

NOTES: 1. FINISH - ALL WALNUT SURFACES MUST HAVE 3 COATS OIL-LUX
 ALL WALNUT EDGING TO HAVE 1/8 RAD.

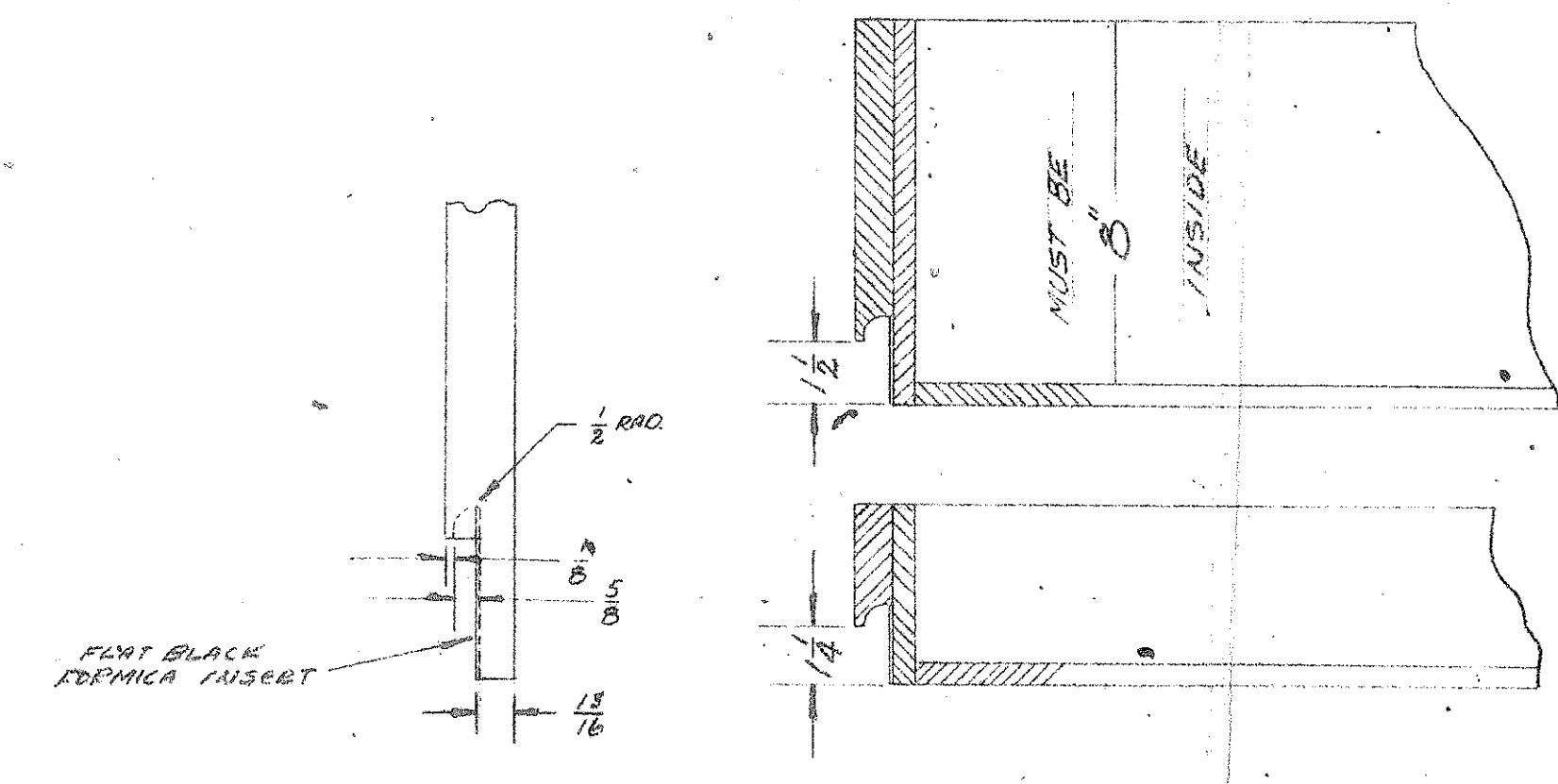

DRILL A 1\"/>

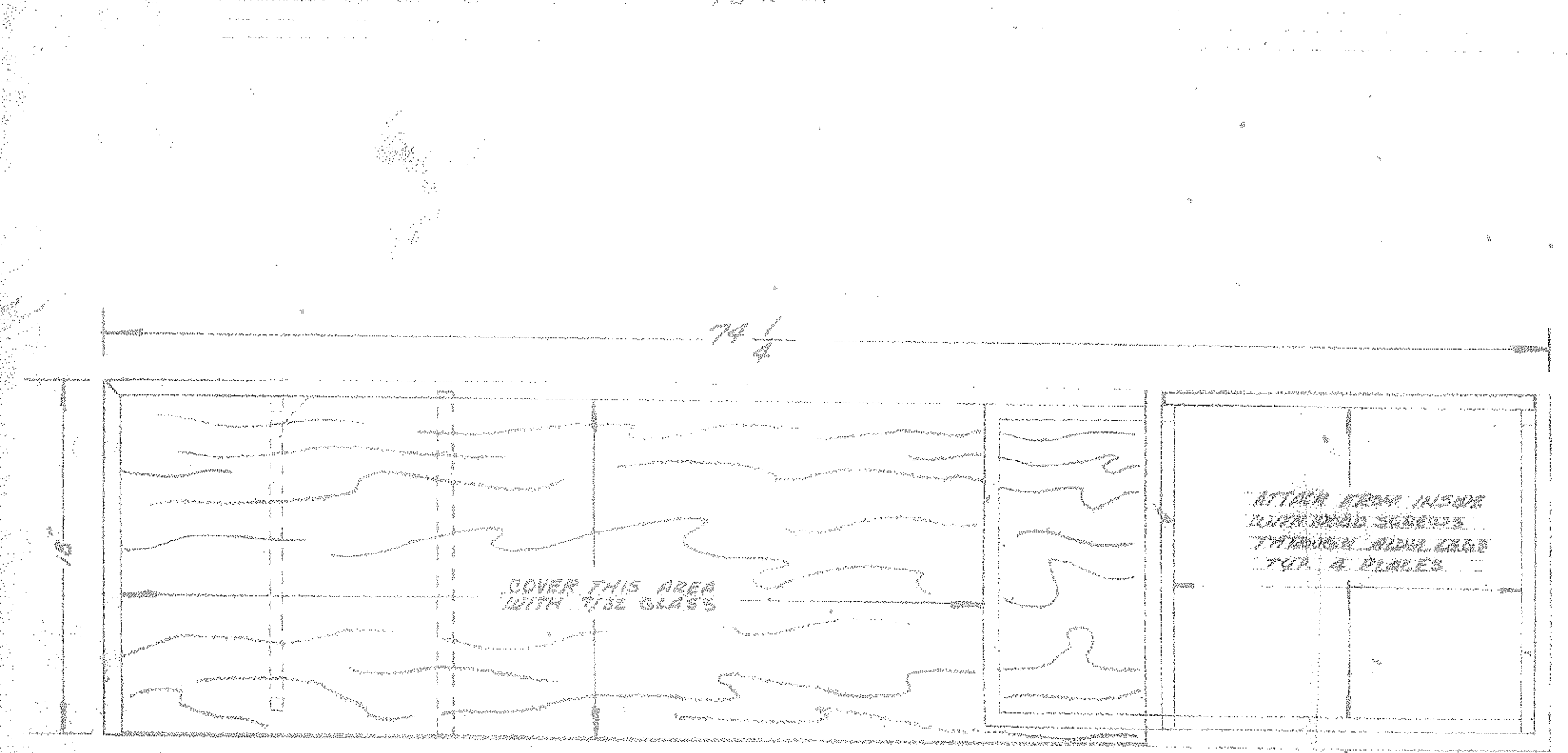
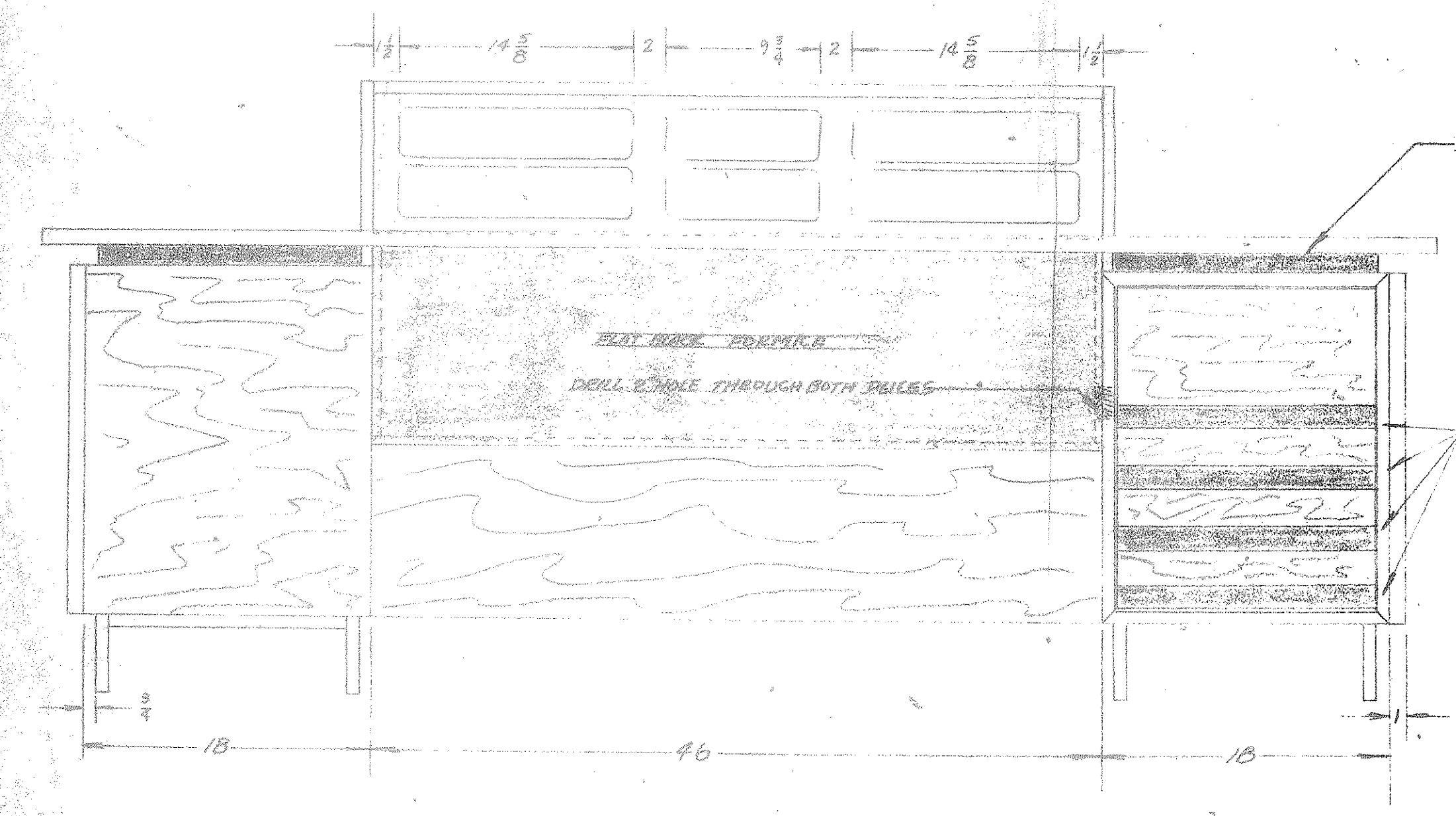
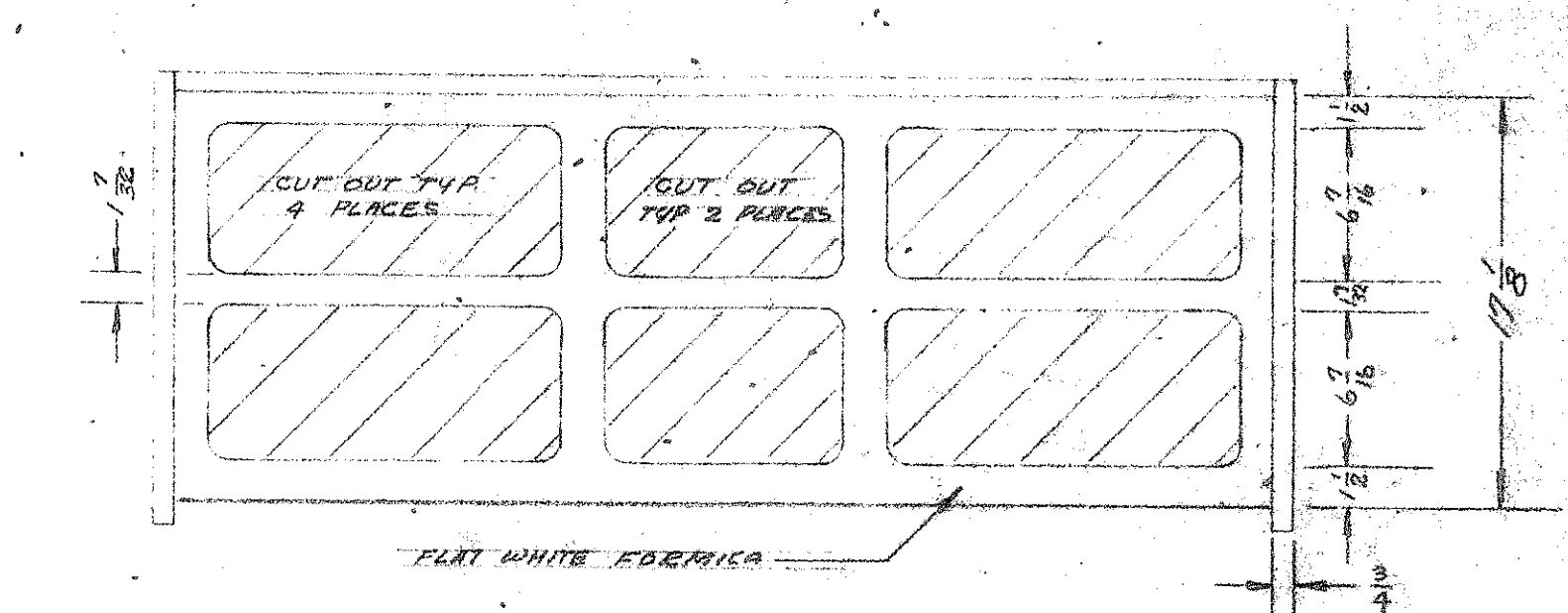
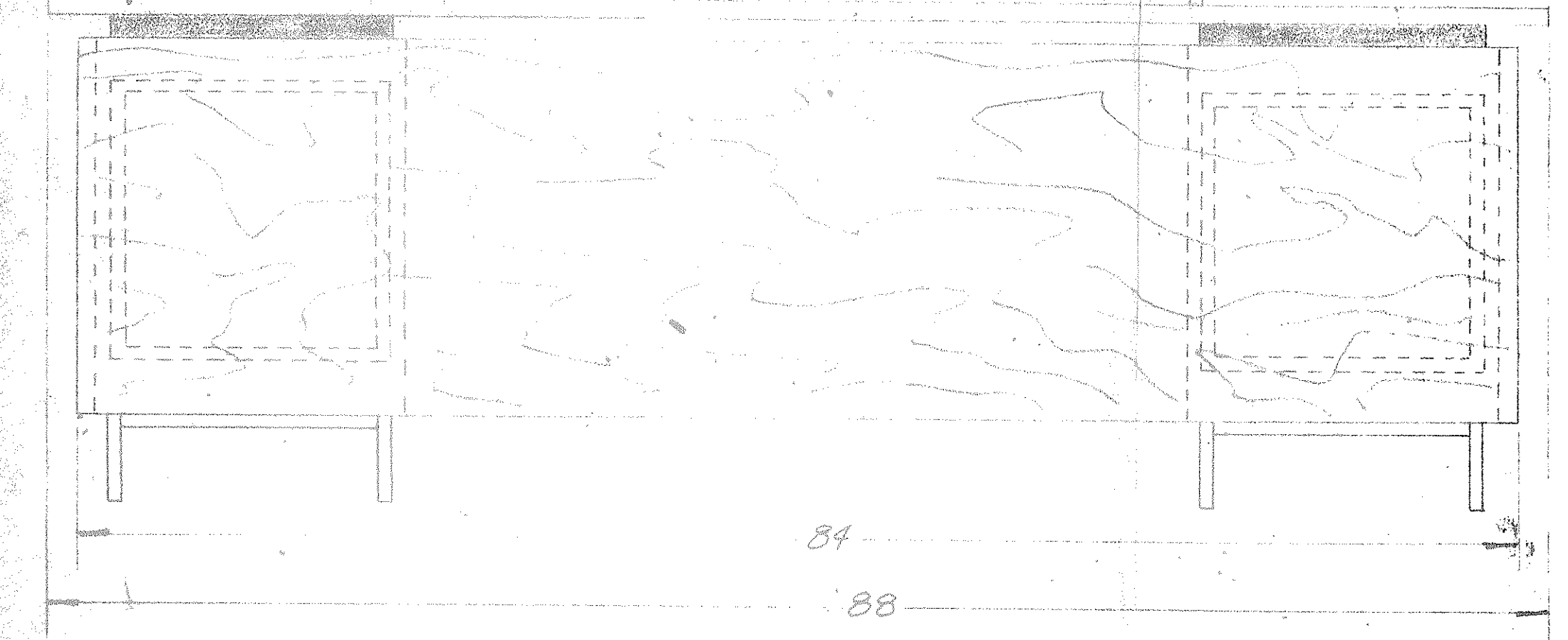
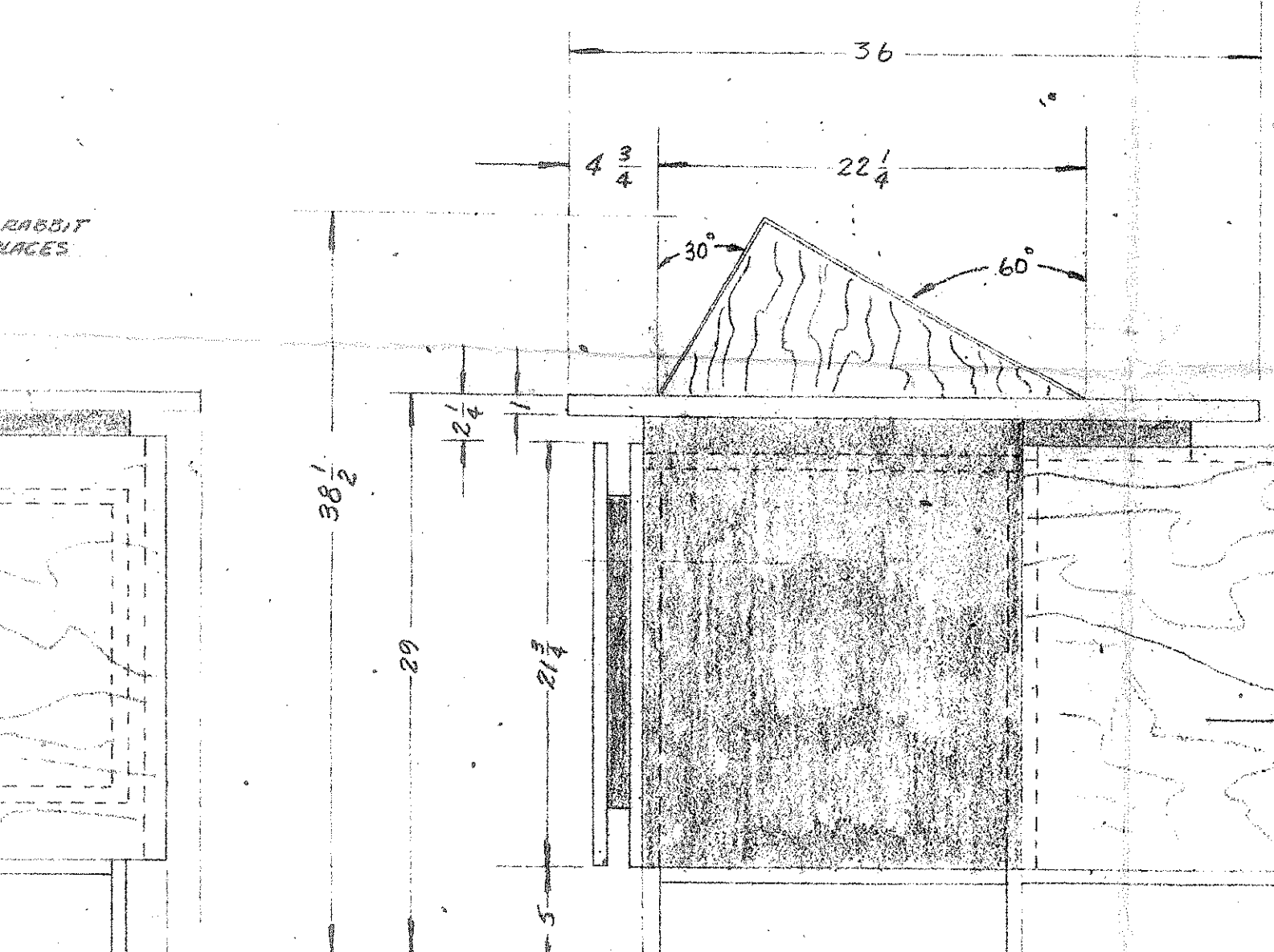
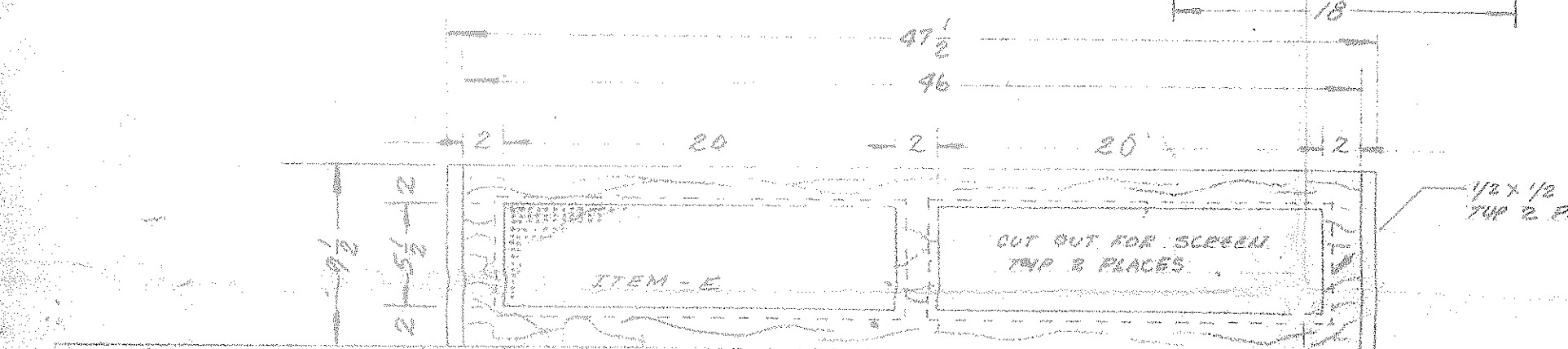
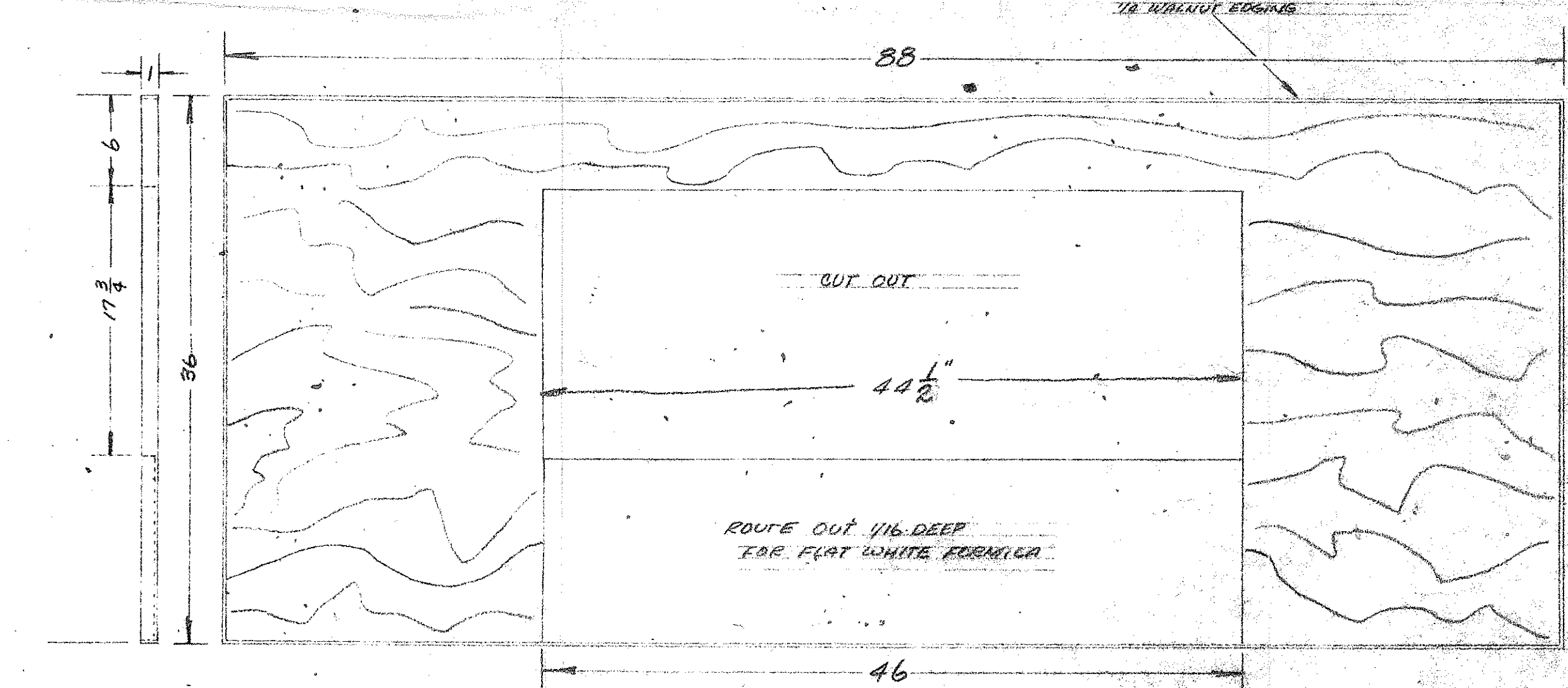
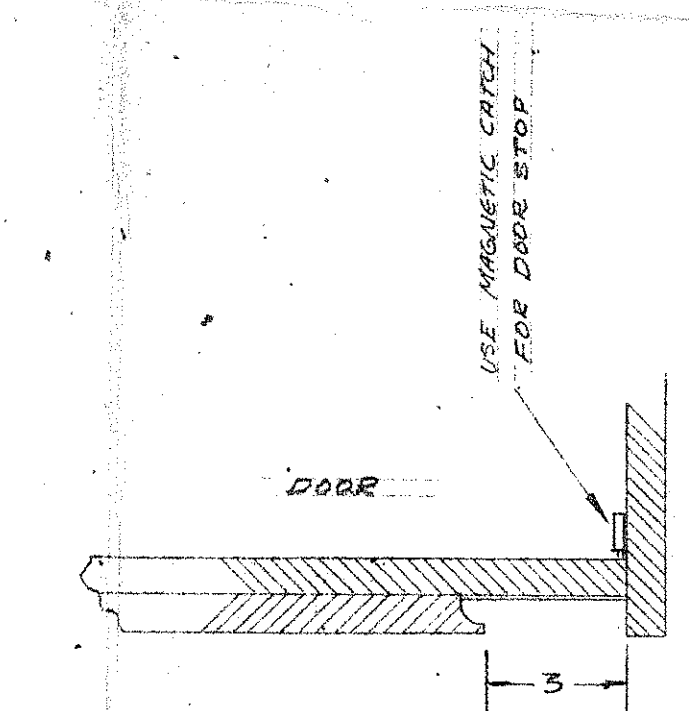
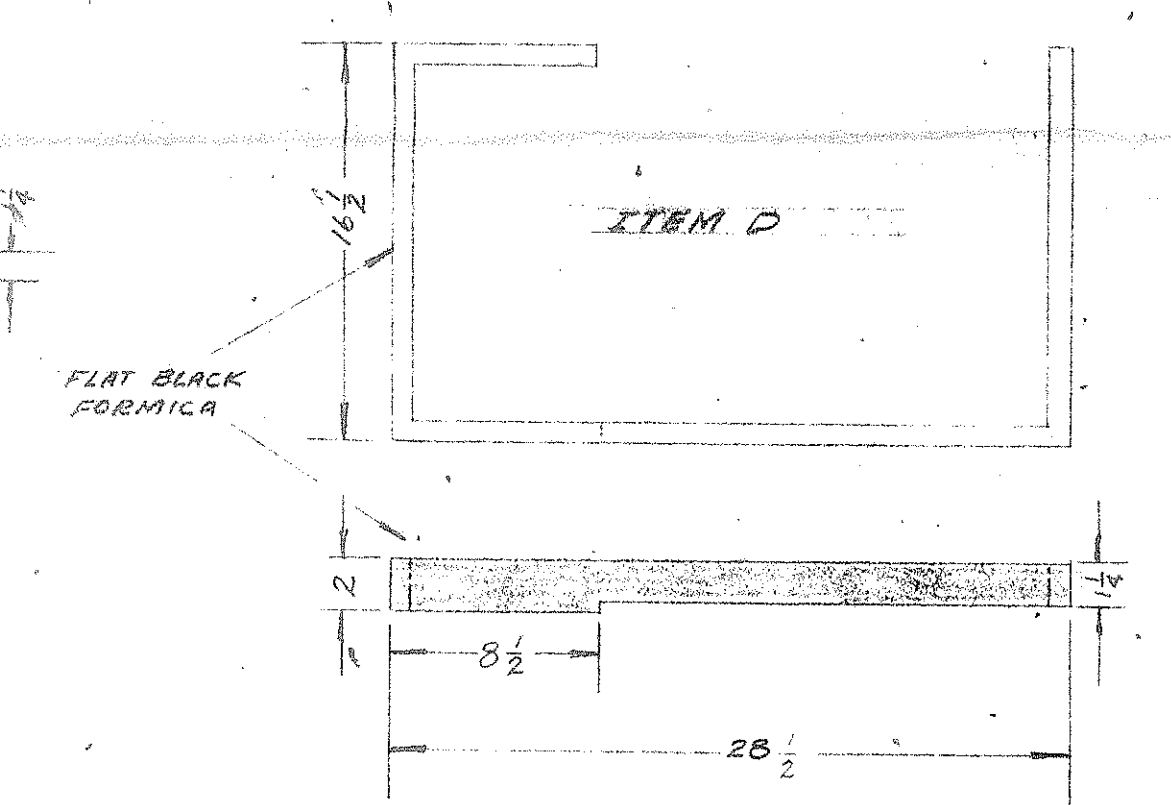
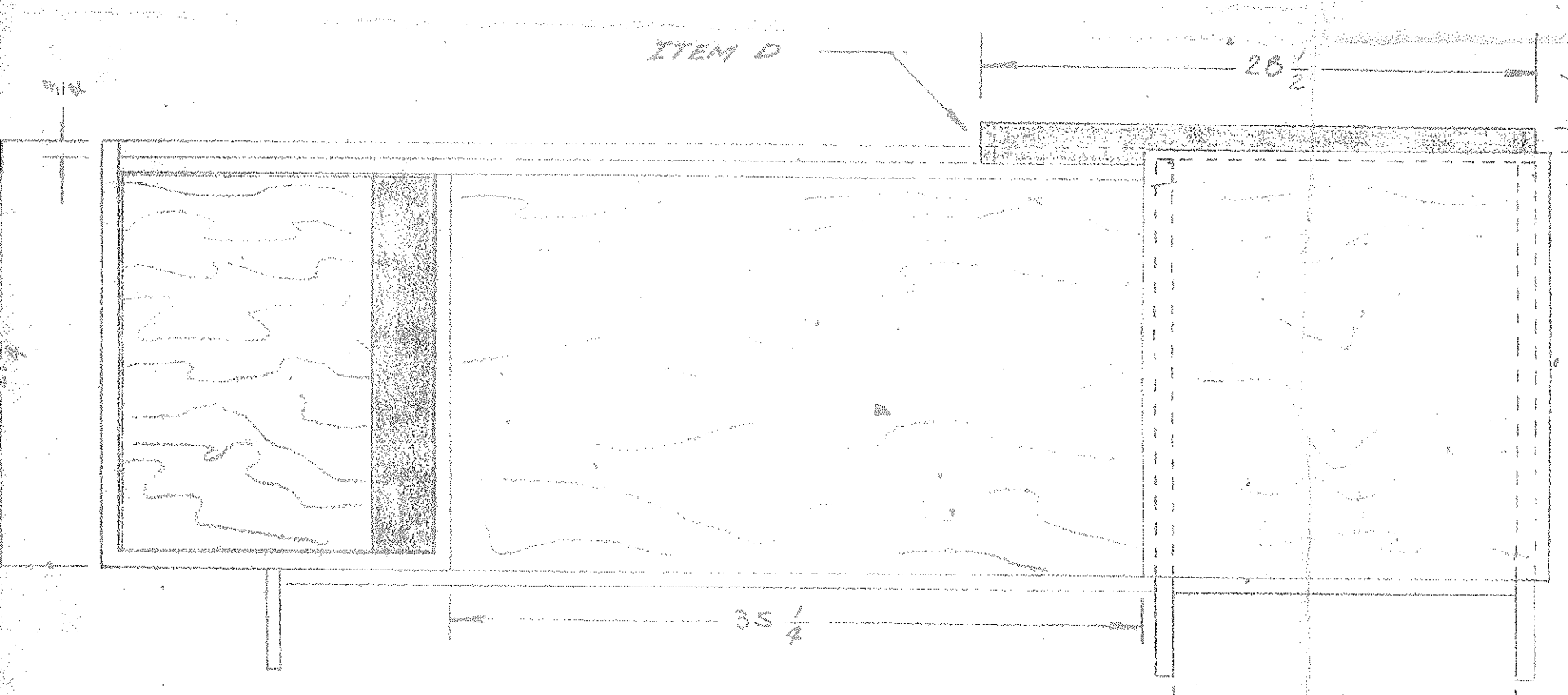
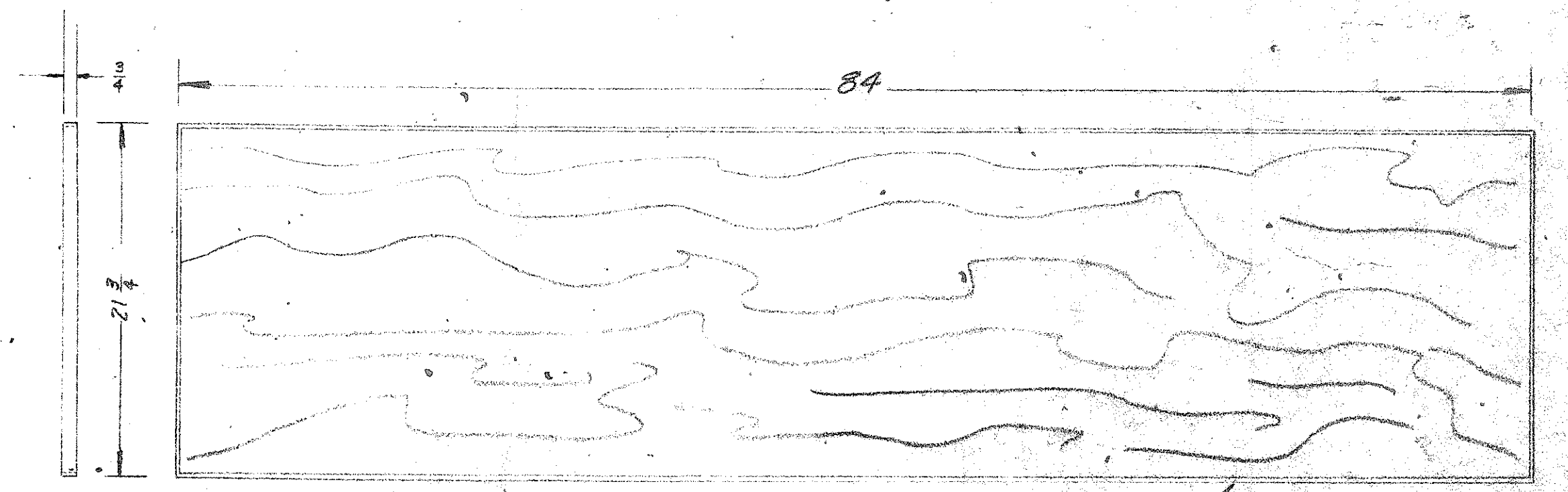

ITEM B
 TOP DRAWER MUST BE 8\"/>

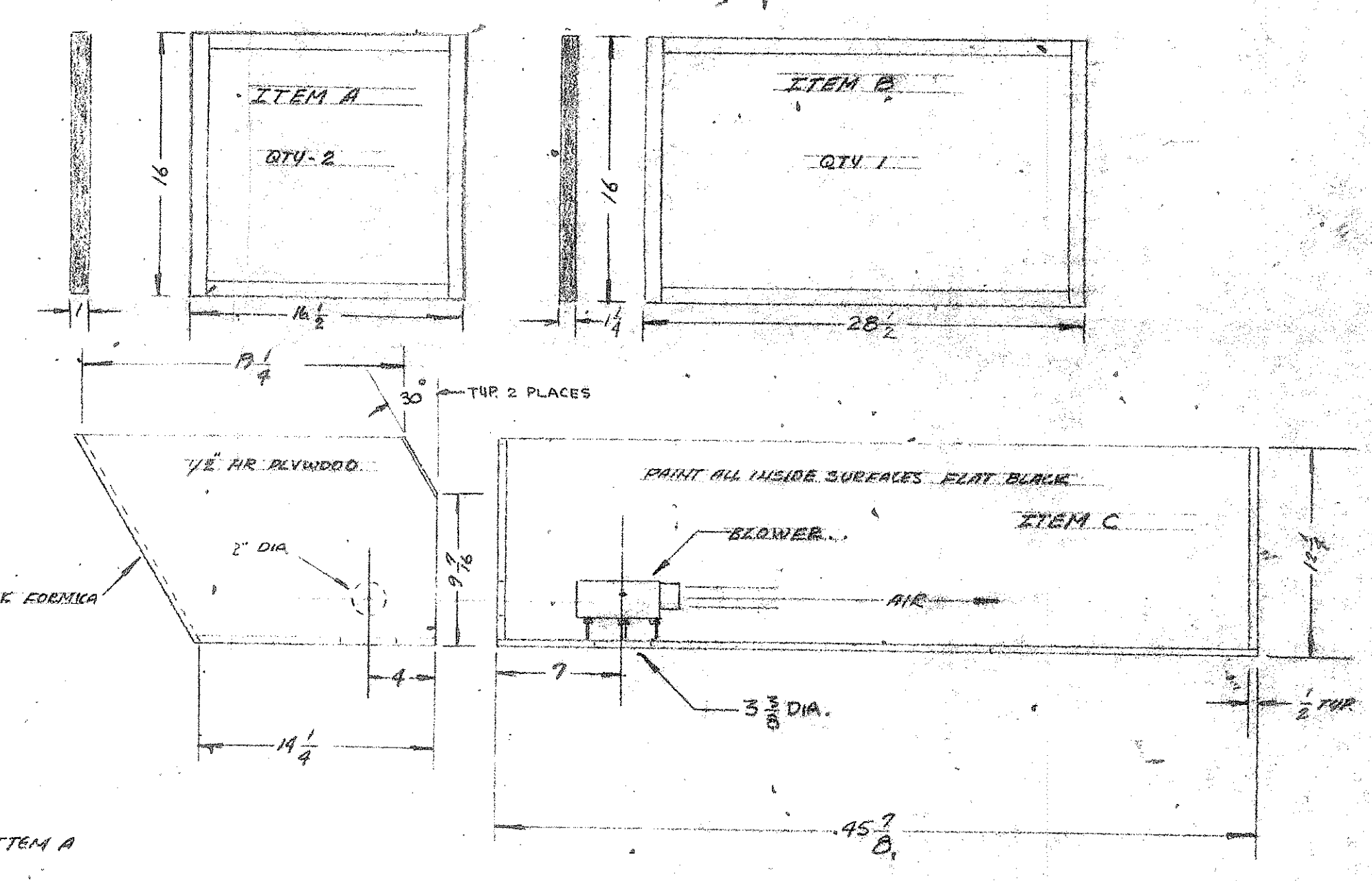
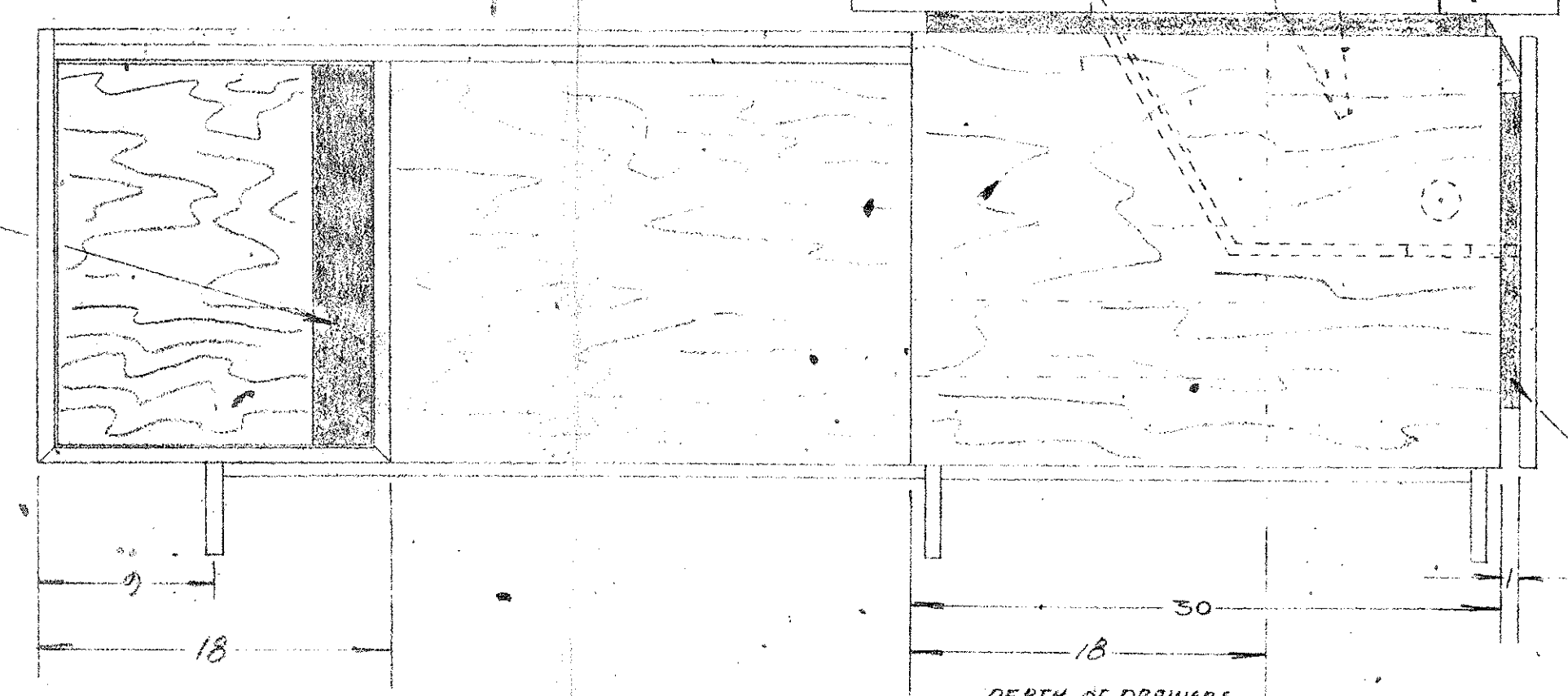

AMATEUR OPERATORS DESK
 DRAWN BY KOK CONNER
 SCALE 1/8\"/>